

ZEB

HORIZON RT

Hardware User Guide



Notes

The software and hardware described in this guide is furnished under licence and may only be used or copied in accordance with the terms of the licence.

Copyright © GeoSLAM Ltd. 2022

Revision: 1.0

Release date: 1 August 2022

All rights are reserved. No part of this publication or the components it describes may be reproduced, stored in a retrieval system or transmitted, in any form, or by any means, electronic, mechanical, photocopying, recording, or otherwise, without prior written consent from GeoSLAM Ltd.

GeoSLAM Ltd. provides this guide “as is”, without warranty of any kind and reserves the right to make improvements and/or changes to the product described in this guide at any time and without notice.

GeoSLAM Ltd. equipment should not be used as a primary navigation device.

CLASS A COMPUTING DEVICE. This equipment has been tested and found to comply with the limits for a Class A digital device, pursuant to Part 15 of the FCC rules. These limits are designed to provide reasonable protection against harmful interference when the equipment is operated in a commercial environment. The equipment generates, uses and can radiate radio frequency energy and, if not installed and used in accordance with the user guide, may cause harmful interference to radio communications. Operation of this equipment in a residential area is likely to cause harmful interference, in which case the user will be required to correct the interference at their own expense.

SOFTWARE IS PROVIDED AS IS. To the maximum extent permitted by law, the manufacturer (GeoSLAM Ltd.) and its suppliers disclaim all warranties, either express or implied, including, but not limited to implied warranties of merchantability and fitness for a particular purpose, with regard to the SOFTWARE, the accompanying written materials, and any accompanying hardware. You may have other rights which vary from country to country.

NO LIABILITY FOR CONSEQUENTIAL DAMAGES. To the maximum extent permitted by applicable law, in no event shall the company or its suppliers be liable for any damages whatsoever (including without limitation, direct or indirect damages for personal injury, loss of business profits, business interruption, loss of business information, or any other pecuniary loss) arising out of the use of this product, even if the company has been advised of the possibility of such damages. In any case, the company's and its suppliers' entire liability shall be limited to the amount actually paid by the owner of the product for the product. Because some states/jurisdictions do not allow the exclusion or limitation of liability for consequential or incidental damages, the above limitation may not apply to the user.

Table of Contents

1.	Introduction	3
1.1.	Specification	3
2.	List of Parts	4
3.	Battery	5
3.1.	Specification	5
3.2.	Recharging	5
3.3.	Capacity and Run-Time Display	5
3.4.	Battery Care	6
3.5.	Transportation	6
4.	Safety	7
4.1.	General Safety	7
4.2.	Laser Safety	7
4.3.	Electromagnetic Compatibility	7
4.4.	Battery Safety	7
4.5.	System Disposal	7
4.6.	Further Help and Information	8
5.	Principal of Operation	9
6.	Usage Guidelines	9
6.1.	The Environment	9
6.2.	Loop Closure	9
6.3.	Transitioning between Environments	10
6.4.	Walking Speed	10
6.5.	Minimum and Maximum Range	10
6.6.	Duration of Scanning	10
6.7.	Survey Areas with Restricted or Difficult Access	10
6.8.	Moving Objects in the Environment	10
7.	Device Connection	11
7.1.	Wireless Connection	11
7.2.	Wired Connection	12
8.	Data Capture	13
8.1.	Connecting the Hardware	13
8.2.	Data Capture using the Web Interface	14
8.3.	Data Capture without using the Web Interface	18
8.4.	LED Status Table	19
8.5.	LED Error Table	20
9.	Data Management	21
9.1.	Downloading Data	21
9.2.	Deleting Datasets	22
9.3.	Downloading to a USB storage Device	23
10.	Data Processing	24
10.1.	GeoSLAM Connect Software	24
11.	Appendices	27
11.1.	Appendix 1 – USB Prepare Tool	27
11.2.	Appendix 2 – Air Transport Certificate	28
11.3.	Appendix 3 – Dimensional Drawings	29

1. Introduction

The ZEB Horizon RT portable laser scanner provides a rapid and simple means of capturing 3D point cloud data. Data is captured as the user walks through the area of interest. The ZEB Horizon RT negates the need for time consuming scanner set-ups and data registration associated with traditional terrestrial laser scanning methods.

Provided the simple guidelines set out in this manual are adhered to accurate 3D point clouds can be generated in a fraction of the time taken with traditional terrestrial laser scanning methods.

1.1. Specification

Maximum range	100m
Points per scan line	1800
Field of view	360° x 270°
Scan rate	300,000 points/s
Scan range noise	±30mm
Frequency	10Hz
Laser wavelength	903nm
Horizontal angular resolution	0.20°
Protection Class	IP 54
Power supply	14.8VDC ~ 1.5A
Weight	Scanner head 1.45kg Datalogger (inc. battery) 1.40kg

2. List of Parts

Part no.	Description
1 GS_610090	ZEB Horizon handheld laser scanner
2 GS_610334	ZEB Horizon Real-time datalogger
3 PAG_9307GS	14.8V Lithium-Ion Battery
4 GS_610098	ZEB Horizon main cable
5 PAG_9713V	14.8V Battery Charger
6 GS_610121	ZEB Horizon Reference Base
7 GS_310025	USB storage device containing GeoSLAM Connect licence
8 SWA_138576	ZEB Horizon backpack
9 OPT_8248	Datalogger shoulder strap
10 GS_610253	ZEB Horizon Phone Holder



Figure 2-1

3. Battery

3.1. Specification

Output voltage	14.8V nominal
Capacity	6.1Ah (+/-5%) 90Wh
Charge voltage	16.8V
Weight	0.57kg
Charging temperature	0°C to 40°C
Life cycle	>300 cycles
Protection	Over current, over voltage, under voltage, thermal
Transportation	UN 38.3 transportation test certified

3.2. Recharging

Plug the charger into the AC mains – the LED light will glow green.

Plug the charger lead firmly into the battery the LED light will change to red to indicate charging. When the LED light changes back to green, the battery is fully charged.

Disconnect the charger from the battery and from the AC mains.

⚠ Do not leave the charger connected to the battery for long periods after the battery is charged.

3.3. Capacity and Run-Time Display

A single button press of the display button on the side of the battery shows a percentage figure of available capacity, to a resolution of 1%.



The accuracy of the display is maintained by tracking battery performance and adjusting calibration values to compensate for the ageing of the cells.

When battery is fully-discharged the display will indicate 3 dots as below.



When the battery is fully charged the display will indicate 100%.



When connected to the ZEB Horizon RT that is powered on, two presses of the battery's display button will show a predicted run-time against the given load, expressed in hours and minutes.



The Capacity display senses the orientation of the battery and adjusts to ensure legibility.

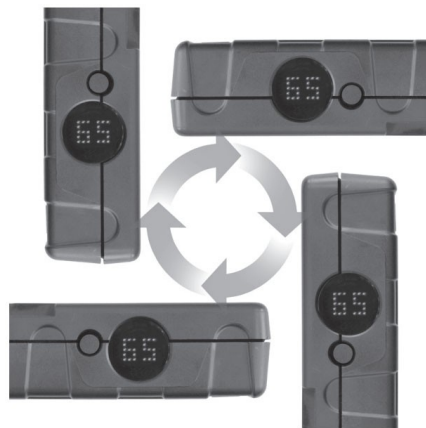

3.4. Battery Care

DO NOT dispose of in normal household waste. DO NOT attempt to dismantle the battery.

DO NOT short circuit the battery.

ONLY use the charger supplied with the battery. The battery should be charged fully before use.

If storing the battery, store in a charged state. Recharge after every 6 months.

Excess heat will degrade the battery rapidly. Always store the battery in a cool dry place. DO NOT leave for long periods in the sun or in a hot vehicle.

It is recommended to recharge the battery within 12 hours if fully discharged. The battery is splash proof but not waterproof

⚠ Do not immerse the battery in water.

3.5. Transportation

The battery has been tested and passed section 38.3 of the UN Manual of Tests and Criteria (UN Transportation Testing) as required by the IATA Dangerous Goods Regulations (2016), Section 2.3.5.9. The battery is below the 100Wh limit for transportation on passenger planes. For the purposes of air transportation, the battery is classed as “Packed with equipment” (ICAO/IATA Packing Instruction 966, Section II) – Cells or batteries contained in a package with associated electronic equipment. Special rules may apply to the transportation of spare batteries. It is recommended that you check with your local air transportation safety authority and/or the proposed air carrier for specific requirements on lithium battery transportation.

⚠ Never ship a damaged battery by air transportation.

4. Safety

4.1. General Safety

The ZEB Horizon RT should only be used by trained operators. Always follow basic safety precautions when operating the ZEB Horizon RT to reduce the risk of personal injury and to prevent damage to the equipment. Do not operate the equipment with suspected defects or obvious mechanical damage. Please refer all servicing of the equipment to qualified service personnel. Only use the components and accessories supplied with your system or other accessories recommended by GeoSLAM Ltd. Before operating the system for the first time please read this manual in full.

The equipment contains sensitive electrical and mechanical parts and thus requires appropriate handling. Do not bend or pull the cables forcibly. Never push objects of any kind into the connectors or sockets. Keep the equipment out of the reach of children. Under no circumstances should any modifications be made to the ZEB Horizon RT without prior written permission from GeoSLAM Ltd.

4.2. Laser Safety



The ZEB Horizon incorporates a Velodyne Puck Lite (VLP-16 Lite) laser scanner. The Puck Lite is classified as a CLASS 1 Laser Product in accordance with IEC 60825-1:2007 & 2014. *Equipment classification and requirements.* Class 1 Laser Products are safe under reasonably foreseeable conditions of operation, including the use of optical instruments for intra-beam viewing.

4.3. Electromagnetic Compatibility

The ZEB Horizon meets or exceeds the following standards:

EN 301 489-17 V3.2.4 (2020-09), EN55035:2-17 and EN55032:2015, Electromagnetic compatibility of multimedia equipment- Emission Requirements (CISPR 32:2015) and Immunity requirements

CFR 47 Code of Federal Regulations: Pt 15 Subpart B- Radio Frequency Devices - Class A Unintentional Radiators

This equipment has been tested and found to comply with the limits for a Class A digital device, pursuant to part 15 of the FCC Rules. These limits are designed to provide reasonable protection against harmful interference when the equipment is operated in a commercial environment. This equipment generates, uses and can radiate radio frequency energy. If not installed and used in accordance with the instruction manual this may cause harmful interference to radio communications. Operation of this equipment in a residential area may cause interference.

4.4. Battery Safety

DONOT attempt to dismantle the battery. DONOT short circuit the battery.

ONLY use the charger supplied with the system.

Excess heat will degrade the battery rapidly. Always store the battery in a cool dry place. DONOT leave for long periods in the sun or in a hot vehicle.

The battery is splash proof but not waterproof ⚠ Do not immerse in water.

4.5. System Disposal



When the ZEB Horizon RT reaches the end of its life-cycle please dispose of the equipment in accordance with Directive 2002/96/EC on Waste Electrical and Electronic equipment (WEEE).

GeoSLAM Ltd is prepared to take back the waste equipment and accessories free of charge at the manufacturing unit in Ruddington, UK for proper treatment with the objectives of the WEEE.

4.6. Further Help and Information

In the event of a problem that cannot be resolved using the information supplied, please contact GeoSLAM. You can also gain assistance through the support page on our website: <https://geoslam.com/support>

For further assistance, contact GeoSLAM Technical Support by telephone or email. Our Customer Support personnel will discuss your situation, determine the cause of the problem and provide the appropriate technical assistance.

Contact GeoSLAM by any of the following methods:

Phone: +44 (0) 1157 270740 (all countries)

Phone: +1-833-444-7907 (US & Canada)

Email: support@geoslam.com

5. Principal of Operation

The ZEB Horizon consists of a time-of-flight laser range sensor (LIDAR) coupled to an inertial measurement unit (IMU). The LIDAR sensor is mounted on motor drive that rotates the sensor through 360 degrees to enhance the sensor's 3D field of view. A novel 3D simultaneous localization and mapping (SLAM) algorithm is used to combine the lidar and IMU data to generate accurate 3D point clouds.

The ZEB Horizon RT scanning head captures raw laser range measurement and inertial data. This data is registered into a homogenous 3D point cloud in near real time by the ZEB Horizon RT datalogger. The data can be post processed using the GeoSLAM Connect processing application.

6. Usage Guidelines

This chapter provides guidelines for how the ZEB Horizon RT should be used to achieve the best possible results. Prior to conducting a survey, the user should plan the proposed survey path in order to identify potential problem areas, e.g. feature poor environments, doorway transitions and stairwells. In these areas, the user should plan how to conduct the survey taking into account the recommendations in this chapter. The plan should also make provision for "closing loops" wherever possible. Please adhere to these guidelines in order to achieve the best results.

6.1. The Environment

The SLAM algorithm used to process the raw laser scan data into a 3D point cloud relies on there being features in the scanned environment that are repeatedly scanned as the operator passes through the scanned environment. For a feature to be significant the ratio of its size to its range must be approximately 1:10, e.g. at 5m range for a feature to be significant it must be >0.5m in size. 'Feature poor' environments include open spaces and smooth walled passageways. In smooth walled passageways there may not be sufficient features in the direction of travel for the SLAM algorithm to determine forward motion. In feature poor environments we recommend the following steps are taken:

- If possible augment the environment with additional features. e.g. boxes in a corridor or a parked vehicle in an open field.
- Ensure that whatever limited features are available are scanned repeatedly as you move through the environment by pointing the ZEB Horizon RT in the direction of the feature. By doing so more measurement points are made of the feature increasing the likelihood that it will be used by the SLAM algorithm. This is particularly important when the feature is at long range (>10m). e.g. when scanning a smooth walled passageway where the only feature in the direction of travel is the end wall or door.
- Avoid scanning moving objects (e.g. passing pedestrians or vehicles) as the SLAM algorithm may lock on to these objects as static features.

6.2. Loop Closure

The SLAM algorithm used to process the raw scan data into a point cloud uses a method analogous to the Traverse technique used in survey practice, in that a previously known position is used to determine its current position. This method can result in the compounding of any error introduced causing measure position to "drift". It is good survey practice to "close the loop" by re-surveying a known position so that the compounded error can be spread around the loop.

As a minimum, it is required that the operator must start and end the survey in the same position to ensure at least one loop closure. However, it is recommended where possible that the operator closes the loop as often as possible in order to minimise error and improve the accuracy of the resulting point cloud.

In general, it is better to do circular loops rather than "there and back" loops where the survey path simply doubles back on itself. This applies to horizontal and vertical loops, i.e. if possible enter and exit through different doors, move between floors via different stair wells.

It is important to scan the closed loop regions carefully to ensure the key features are scanned from a similar perspective. It may be necessary to turn around if you return to a region from a different direction. This is particularly important in feature poor environments.

6.3. Transitioning between Environments

Extra care must be taken when transitioning between environments, for example passing through a doorway or turning through a tight bend to avoid introducing errors. When transitioning between environments the local view may change abruptly and the SLAM algorithm may have difficulty placing the new environment relative to the previous environment. This may result in rooms either side of a doorway being slightly misaligned.

Transition through doorways slowly and ensure that there is a period when the scanner can view features on both sides of the doorway (i.e. into both rooms).

Try to open all doors before starting the survey. Avoid scanning doors as they are being opened. If necessary, face away from the door and open from behind then pass through the doorway backwards.

Transition around tight bends slowly and ensure that there is a period when the scanner can view features on both sides of the bend.

Take care when transitioning from an enclosed feature rich environment to an open feature poor environment, for example exiting a building. It may be necessary to turn and face the exit and the exterior of the building if no other features are within range.

Avoid scanning any other moving objects (e.g. walking pedestrians) as you pass through a transition.

6.4. Walking Speed

It is recommended that data is captured at walking speed to ensure good coverage and high-resolution data. If the forward movement is too fast there may not be enough repeat scans of features for the SLAM algorithm to be able to process the raw laser data into a point cloud.

6.5. Minimum and Maximum Range

Data within a small range value is not processed (by default) to eliminate data from the scanner operator being included in the final point cloud. Avoid close proximity to walls and ceilings.

The maximum range of the scanner is 100m. During the capture, the point density is reduced as a lower data sample rate required for real-time processing. For real-time visualisation, it is recommended that the range does not exceed 40m between the operator and a large feature (e.g. building, or high voltage pylon) to ensure good point density and to assist the SLAM algorithm (see section 6.1).

6.6. Duration of Scanning

For very large surveys the project should be broken down into more than one scan mission. This is to avoid very large file sizes as well as reduce any drift that might be created in the data. It is recommended that each survey is limited to 30 minutes. At slow walking pace, it is possible to cover 1000-3000m of survey distance.

6.7. Survey Areas with Restricted or Difficult Access

The scanning head can remain stationary for short periods of time whilst the operator negotiates difficult access points (e.g. tight squeezes in cave systems). The scanning head can also be held in the hand and moved up and down to mimic the normal oscillating motion for short periods of time to assist transition through survey areas with restricted or difficult access.

6.8. Moving Objects in the Environment

In most cases the SLAM algorithm is able to handle moving objects in the environment. In order to estimate the sensor trajectory the algorithm assumes a large proportion of the environment is static. However, in some feature poor environments where 3D structure is lacking in some dimensions, moving objects can have a greater impact on the solution. In particular, moving objects should be avoided in long tunnel-like environments (e.g. corridors), relatively open spaces and when transitioning through doorways.

It is best practice not to have other people closely accompany the operator during the scan acquisition as they will be scanned throughout the map leaving streaks of data and potentially corrupting the solution in feature poor environments. If people are required to follow the operator they should ideally maintain a distance of 20m or more from the operator.

7. Device Connection

Communication with the ZEB Horizon RT system is carried out via a network connection to a web enabled device, e.g. tablet, cell phone or PC. A network connection is required for data capture** using the web interface (see Section 7.1) and for data download and management (see Section 9).

The network connection can be either wired by network cable or wireless Wi-Fi connection.

** If required, data captured can also be carried out with a network connection (see section 8.3)

7.1. Wireless Connection

The RT datalogger acts as a Wi-Fi access point with SSID **gs-datalogger24XXXX**, where 24XXXX is the serial number of the datalogger (Figure 7-1). To make a wireless network connection, login to the access point.

The default network security key (password) is **zebedee12**.

The password can be reset by the user using the web interface.

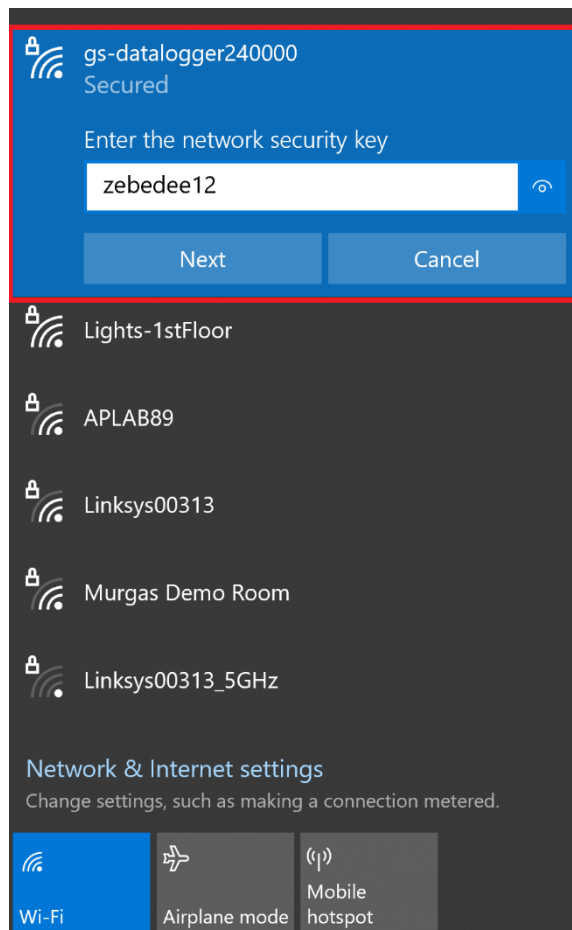

Figure 7-1

7.2. Wired Connection

The datalogger is set to Link-Local IP address 169.254.0.205 which enables connection to web devices set to default Ethernet setting - DHCP “Obtain IP address automatically” without the need to configure IP settings.

To check the Ethernet settings on a Windows™ PC go to:

Control Panel>Network and Internet>Network Connections

Right click o the Ethernet adapter to be checked and select:

Properties>Internet Protocol Version 4 (TCP/IPv4)

Select the **Obtain the IP address** automatically option button if not already set as shown in Figure 7-2 and click **OK** to close the Network Properties dialog boxes.

Connect an Ethernet cable between the datalogger and the web enabled device.

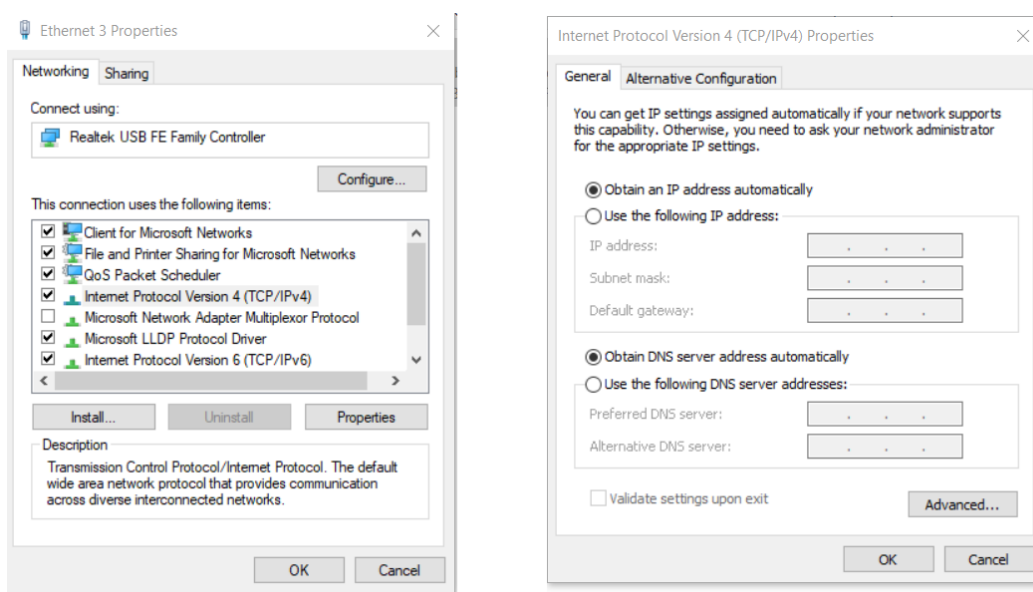

Figure 7-2

8. Data Capture

This section describes how to connect the ZEB Horizon RT hardware, how to collect scan data and how to download the scan data from the datalogger.

There are two modes of data capture:

- Data capture using the web interface: This method allows the user to control the data capture process via a web enabled device such as a cell phone or tablet. The method also provides a real time view of the data as it is captured and a SLAM condition indicator that provides a degree of feedback to the user regarding the robustness of the SLAM solution during the scan. Data capture using the web interface is described in Section 8.2.
- Data capture without the user interface: This method allows the user to capture data without the need for a web enabled device. This method enables the device to be used in the same way as other GeoSLAM mapping products using the status LED's on the scan head and datalogger to indicate the status of the device. There is no real time feedback when using this method. Data capture without the web interface is described in Section 8.3.

8.1. Connecting the Hardware

Connect the battery to the RT datalogger (if not already connected). Ensure the battery is well charged before commencing data capture.

- Connect the ZEB Horizon RT main cable to the 16 way socket on the side of scan head.
- Connect the other end of the ZEB Horizon RT main cable to the 16 way socket on the RT datalogger.

To attach the reference base plate, orientate the ZEB Horizon and plate as shown in Figure 8-1. The base of the ZEB Horizon handle sits within the 'cup' on the top of the reference plate and the alignment pin should be toward the front point of the plate. Fix the plate by tightening the captive screw by hand using the 'D' ring as shown in Figure 8-1 below.



Figure 8-1

8.2. Data Capture using the Web Interface

Step 1: Press the power button on the datalogger to power on the system. Ensure that the scan head is on its back or standing upright using the reference base as the scan head will rotate as part of the boot sequence.

Step 2: Make a network connection (wired or wireless) to a web enabled device as described in Section 7.

Step 3: Open a web browser on the web enabled device and enter:

- a) <http://169.254.0.205/> for wired connection
- b) <http://192.168.102.2/> for wireless connection
- c) <http://gs-datalogger.local/> for either connection

Step 4: The GeoSLAM logo will be displayed briefly while the connection is made then the Start screen is displayed (Figure 8-2).

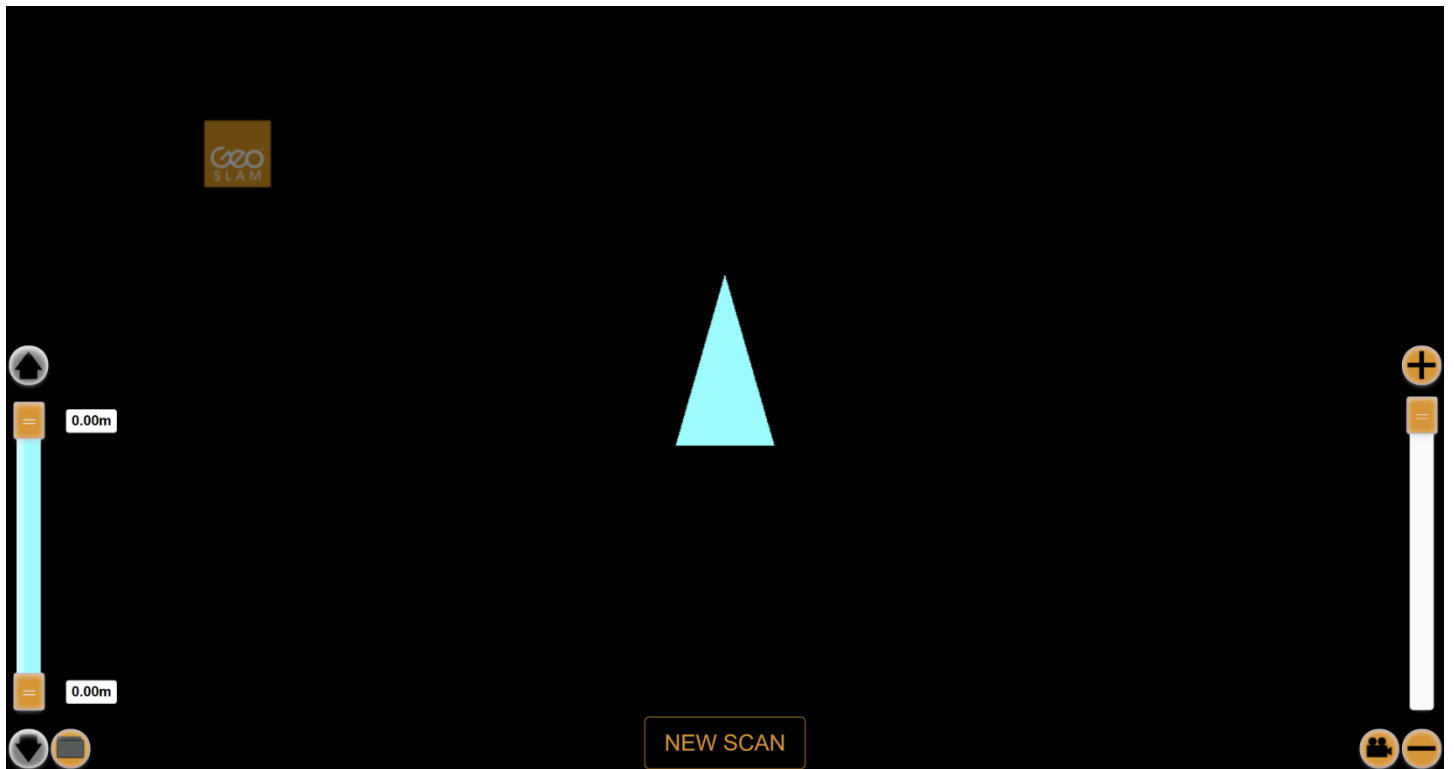

Figure 8-2

Step 5: To start a scan, position the scan head on its back or standing upright using the reference base such that the scan head is free to rotate when the scan is initiated. Click the START button and enter a scan name when prompted (Figure 8-3).

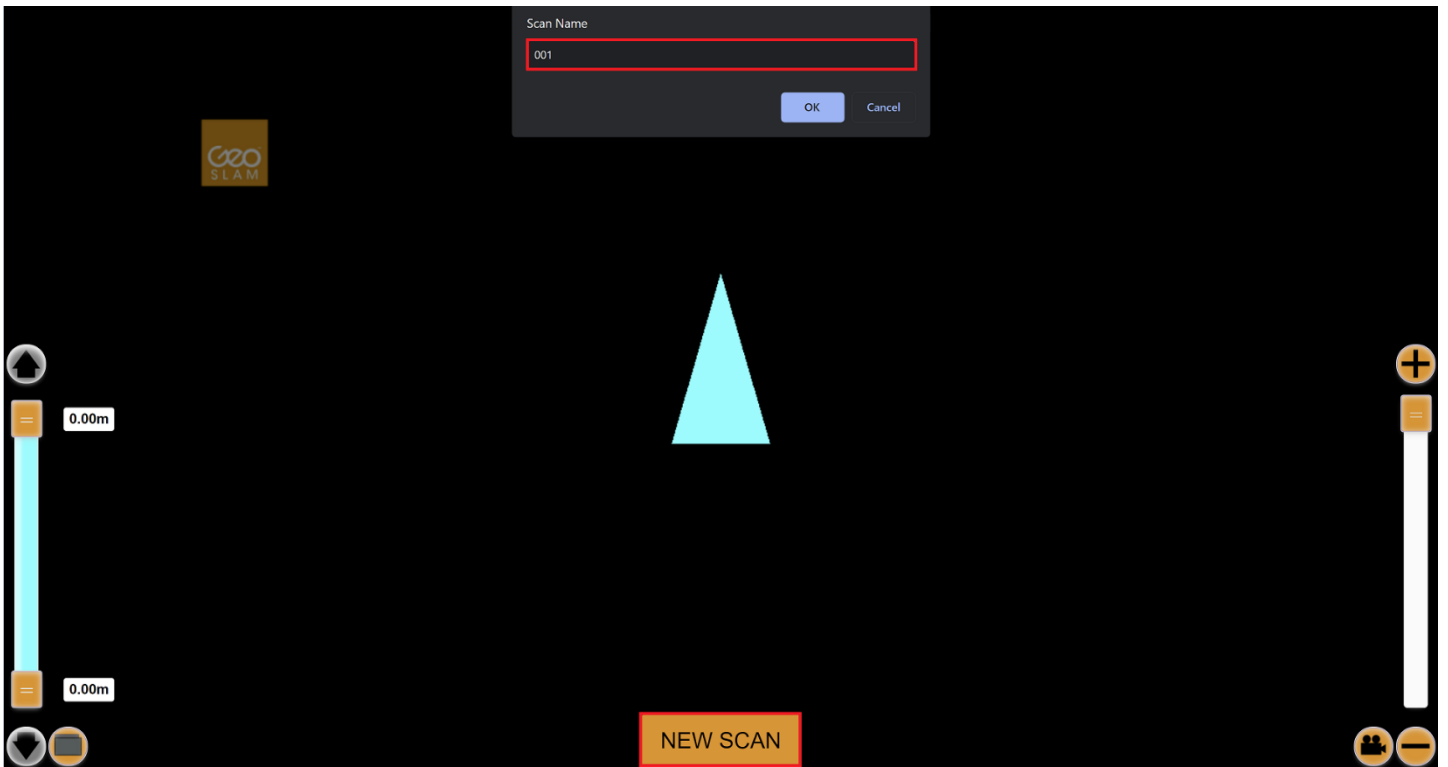

Figure 8-3

Step 6: The system will initialise for approximately 15 seconds (Figure 8-4). The scan head must remain stationary during this period. If the scan head is moved during initialisation the scan will be aborted.

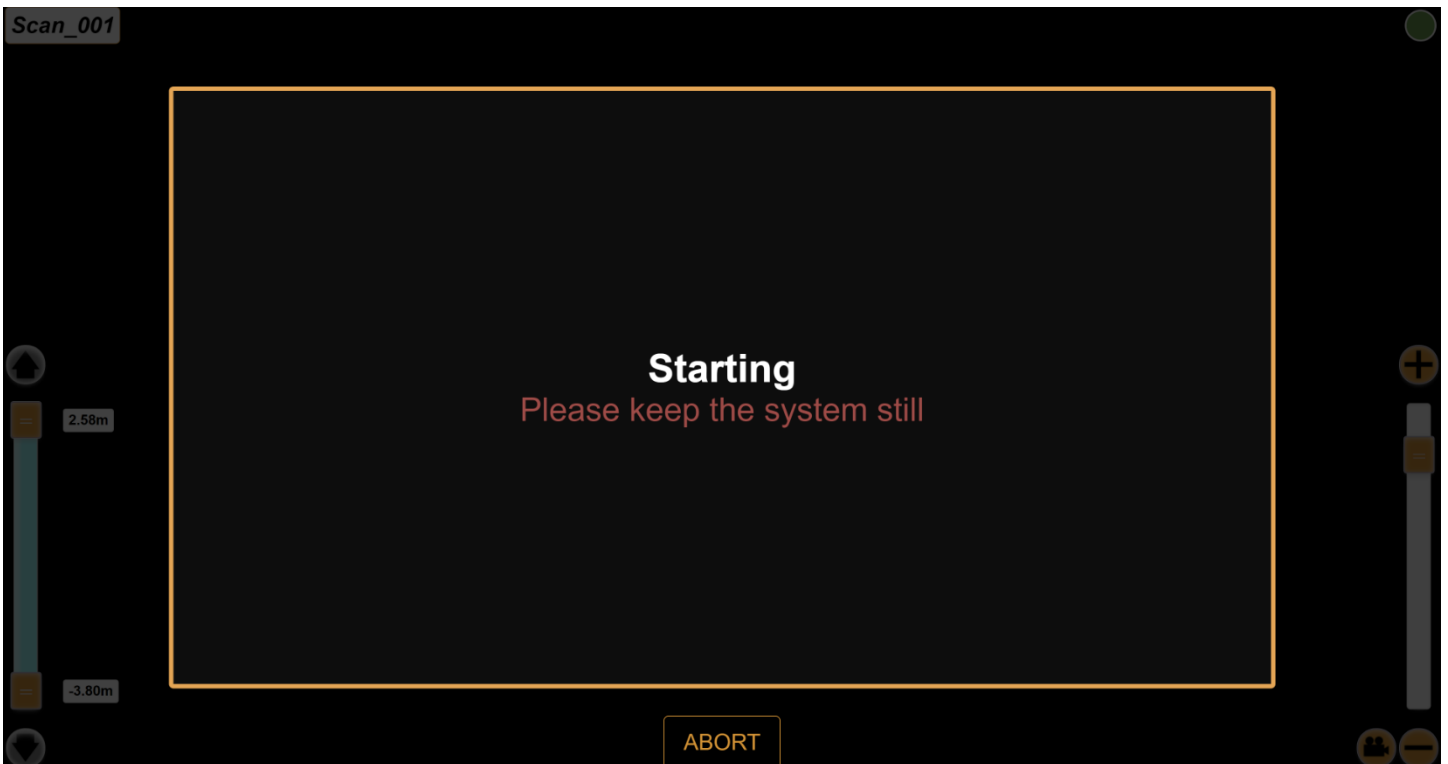

Figure 8-4

Step 7: When the initialisation screen closes the scan head will start rotating and commence the survey. A 3D representation of the scan can be seen in the graphic screen (Figure 8-5).

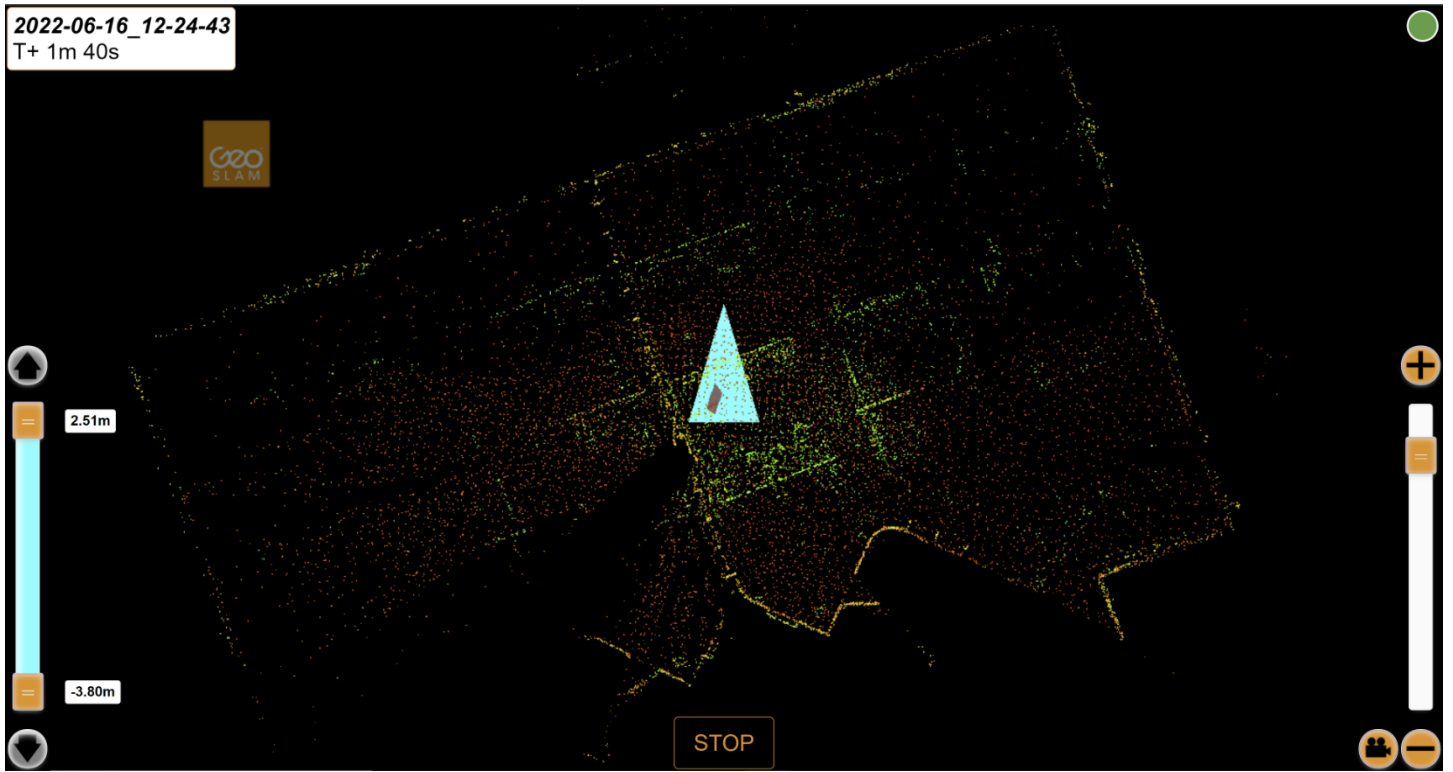



Figure 8-5

It is possible to cycle through different camera views by clicking the camera icon  in the bottom right-hand corner of the screen. The slider on the left of the screen can be used to clip the scan vertically to remove the ceiling or floor.

The slider on the right of the screen can be used zoom in and out.

Step 8: When the survey is complete position the ZEB Horizon RT scan head in approximately the same position as used for initialisation and click the STOP button on the display screen (Figure 8-6).

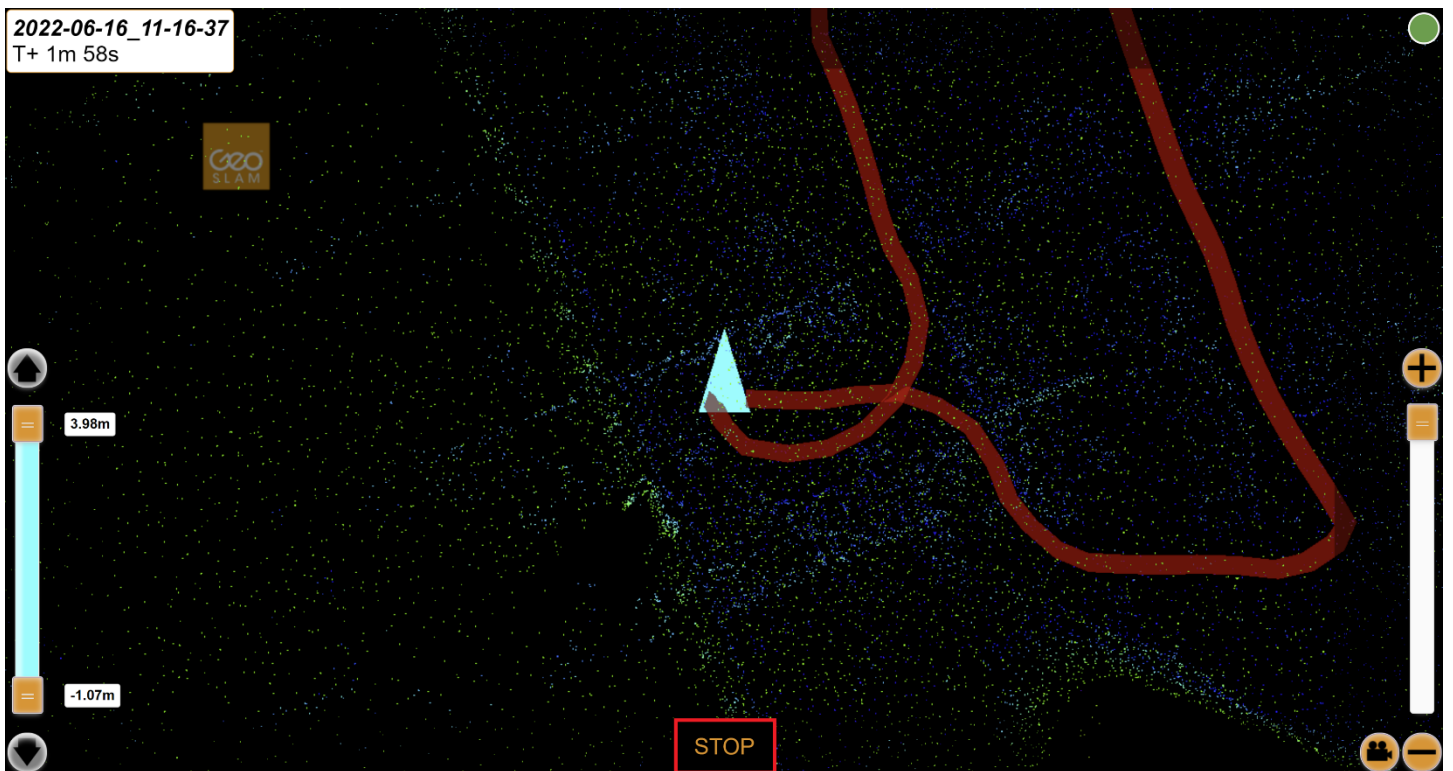

Figure 8-6

Step 9: Once complete the display will revert to the Start screen ready for the next scan.

A draft view of the point cloud can be seen which displays the area covered by the scan. For an accurate representation of the point cloud, the data should be reprocessed in Connect.

The point cloud can be viewed in both orthographic, isometric and perspective modes in order to verify the coverage of the capture (Figure 8-7).

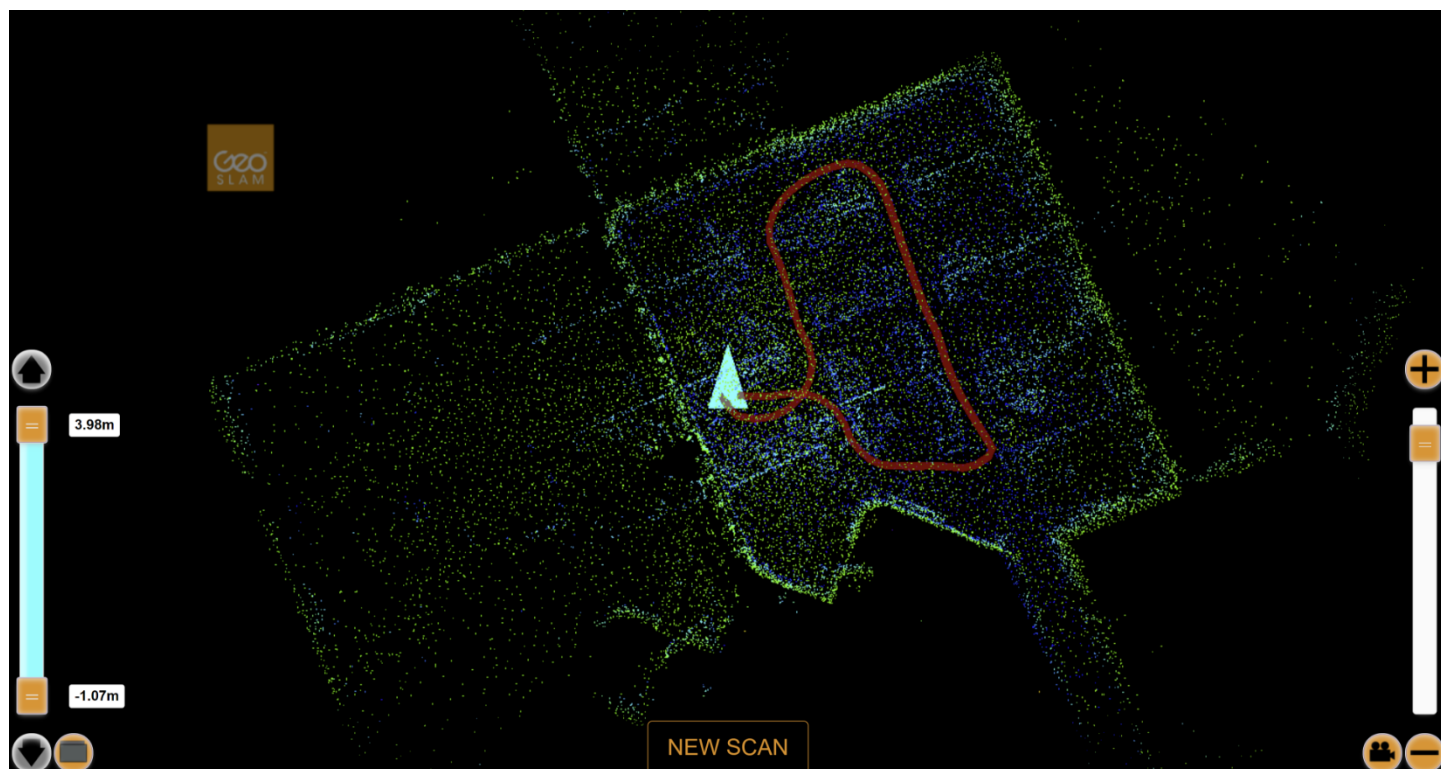

Figure 8-7

















To repeat the scan, or start a new scan, simply position the Horizon RT in a stationary position, click the START button and enter a scan name when prompted.

To shut down the system, long press the power button on the RT data.

⚠ Do not unplug the ZEB Horizon RT scan head from the datalogger until the unit is switched off.

8.3. Data Capture without using the Web Interface

It is possible to capture data without using the web interface. There is no real-time feedback when using this method. Starting and ending scans can be controlled using the Function button on the datalogger. The status of the system is indicated by the STATUS and DATA LEDs on the datalogger and the status LED on the scan head. The table below describes the steps to be taken to capture data with using the user interface and with the status LED indicator states.

		Datalogger LED		Scanhead LED array
		STATUS	DATA	
Step 1	Press the power button on the datalogger to power on the system. Ensure that the scan head is on its back or standing upright using the reference base as the scan head will rotate as part of the boot sequence.			
Step 2	Datalogger booting up.		-	-
Step 3	Connecting to scan head.		-	
Step 4	Standby mode		-	
Step 5	Initiate new scan Long press the function button on either the scan head or the datalogger until the STATUS LED and scan LED array light turns solid red to initiate a new scan			
Step 6	Initialisation mode The scan head must remain stationary for a period of 15 seconds. If the scan head is disturbed during initialisation the system will revert to standby mode (Step 4)		-	
Step 7	Scanning mode After the 15 second initialisation, the STATUS LED and scan head LED array will light green and the scan head will start rotating. Pick up the scanner and conduct the scan.		-	
Step 8	End scan - Data formatting To end the scan, long press the function button on either the scanner head or the datalogger until the scan head stops rotating. The DATA LED will light orange while the scan data is converted to the required output format			
Step 9	Standby mode From stand-by either Initiate a new scan (Step 5), Download the data from the latest scans (section 9), or Shut down by long pressing the power button.		-	

 **The scanner must remain static during initialisation**

During data capture the datalogger can either be carried in your spare hand or carried on your side using the supplied shoulder strap.





 **Only connect the Horizon RT scan head when the RT datalogger is powered off!**

To shut the ZEB Horizon datalogger down long press the power button until two beeps are emitted. The STATUS and DATA LEDs will light red. © 2022 GeoSLAM Ltd













DATA LED's on the datalogger will alternate RED until the system powers down.

⚠ Do not turn the datalogger off until the DATA LED is off

8.4. LED Status Table

STATUS LED on datalogger	LED array on scan head		Description
BLUE flash	-	-	Datalogger booting
BLUE		BLUE	Connecting to scan head
RED pulse		RED LED strobing from left to right	Scanner is in standby mode
RED		RED	Scanner about to enter initiation mode
ORANGE flash		ORANGE flash	The scanner is in initiation mode
GREEN		GREEN	The scanner is scanning mode
DATA LED on datalogger			
ORANGE	-	-	Scan data is being formatted ⚠ Do not turn the datalogger off

8.5. LED Error Table

STATUS LED on datalogger		LED array on scan head		Description
	Single RED flash		Single RED flash	Laser sensor not detected
	Double RED flash		Double RED flash	IMU sensor not detected
	Triple RED flash		Triple RED flash	Laser and IMU sensors not detected
	ORANGE		ORANGE	Datalogger turned off during Data Formatting Shut down paused until data formatting is complete
STATUS LED on datalogger		DATA LED on datalogger		Description
	Synchronous single RED flash		Synchronous single RED flash	Available storage capacity below 20 Gb
	Synchronous double RED flash		Synchronous double RED flash	Available storage capacity below 5 Gb

9. Data Management

This section describes how to manage the data on Horizon RT datalogger, i.e. download datasets for post processing and deleting files. To manage files on the datalogger a network connection is required to a web enabled device such as a tablet or PC. See Section 7 for instructions how to make a network connection to the datalogger.

Open the Horizon RT web interface by entering the system IP address as described in Section 8.2 in a Web Browser.

The “SCAN” page will open by default. To access the list of processed datasets click the File icon  in the bottom right corner of the screen. The interface will switch to the DATA page as shown in Figure 9-1.

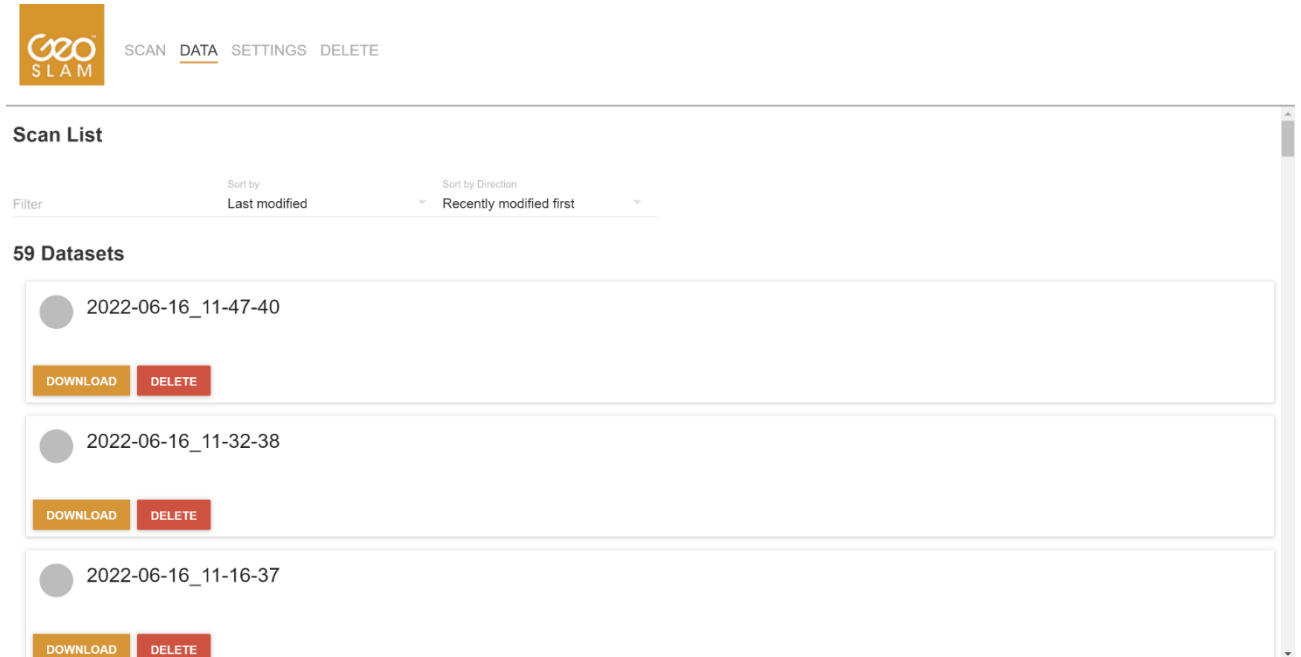

Figure 9-1

9.1. Downloading Data

Files can be downloaded to the connected device by clicking on download, and selecting file type .geoslam (Figure 9-2).

The .geoslam file can be imported into GeoSLAM Connect (see Section 10) for post processing task such as point cloud filtering and export of data in other file formats.

After selecting the download button, ensure that the file extension ends in .geoslam format. IOS and Safari users may experience the file being renamed to **YOUR-DATASET-NAME**.geoslam.mbtiles. The .mbtiles extension can safely be deleted.

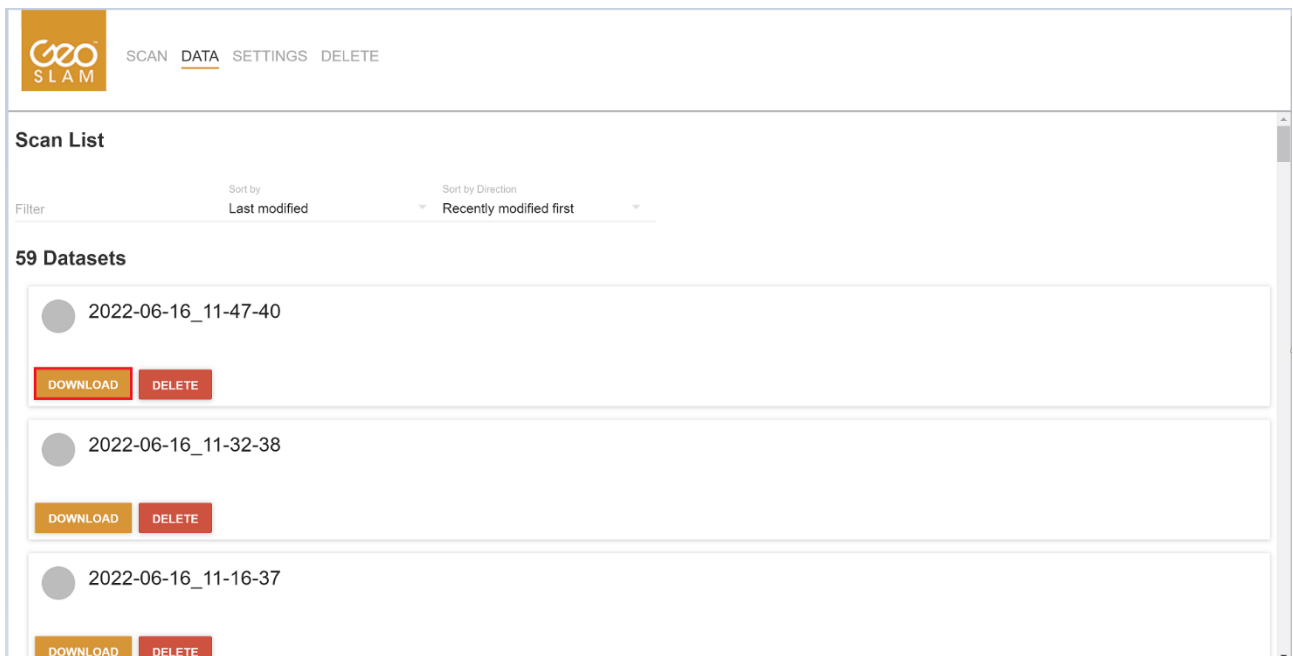

Figure 9-2

⚠ Ensure that the file extension ends in .geoslam to ensure compatibility with Geoslam Connect!

9.2. Deleting Datasets

It is recommended that datasets are deleted from the RT datalogger after they have been downloaded to free up space for subsequent scans. The RT datalogger should not be used as a data storage device.

Datasets can be deleted one at a time by clicking the DELETE button under the target dataset on the DATA page. To delete more than one file at a time select the DELETE page, check the check box against the target datasets and click the DELETE button (Figure 9-3).

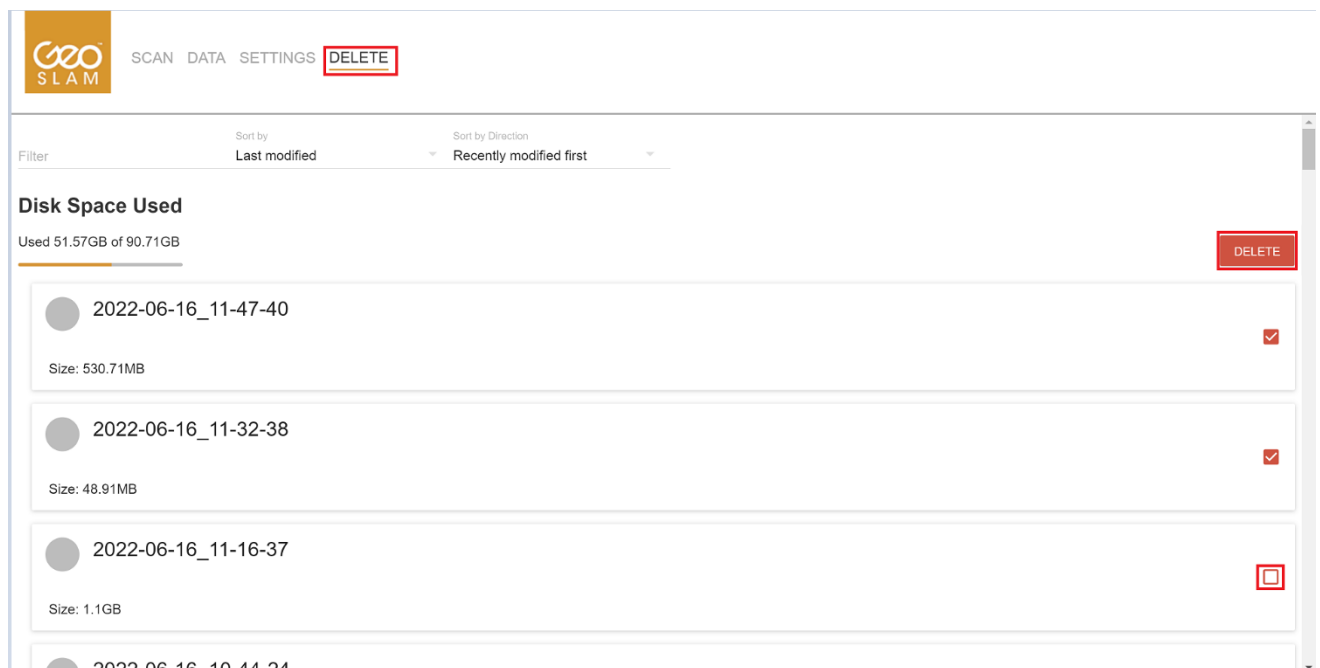

Figure 9-3

9.3. Downloading to a USB storage Device

To download the raw scan data, power on the ZEB Horizon datalogger if not already powered on.

Connect the supplied USB storage device to the USB socket on the datalogger front panel.

The DATA LED light will light green whilst the data is transferring to the storage device.

The USB storage device must not be removed when the DATA LED is lit green.

After a few seconds (dependent on the size of the data files to be transferred) the DATA LED will turn off.

All data that has not previously been transferred will be transferred and the USB storage device can be removed.

⚠ Do not remove the USB storage device while the green DATA LED is lit

The following USB storage device file formats are supported, exFAT, FAT32 and NTFS.

Downloading data is an automatic process whereby only data that has not previously been downloaded will be transferred.

If it is necessary to download a previously saved dataset, please refer to the USB prepare tool in Appendix 11.1.

10. Data Processing

Data collected by the ZEB Horizon RT can be post processed in GeoSLAM Connect software. This section described the basic steps required to import a Horizon RT dataset and export the results in a different formats.

10.1. GeoSLAM Connect Software

The installation of GeoSLAM Connect software is described in a separate User Guide and can be found on GeoSLAM Academy.

Before the raw data can be processed, it must be downloaded from the ZEB Horizon RT datalogger.

Start the Connect Viewer application and click on the “Add New Project” icon in the top left. Choose a suitable project name and click “Create Project”.

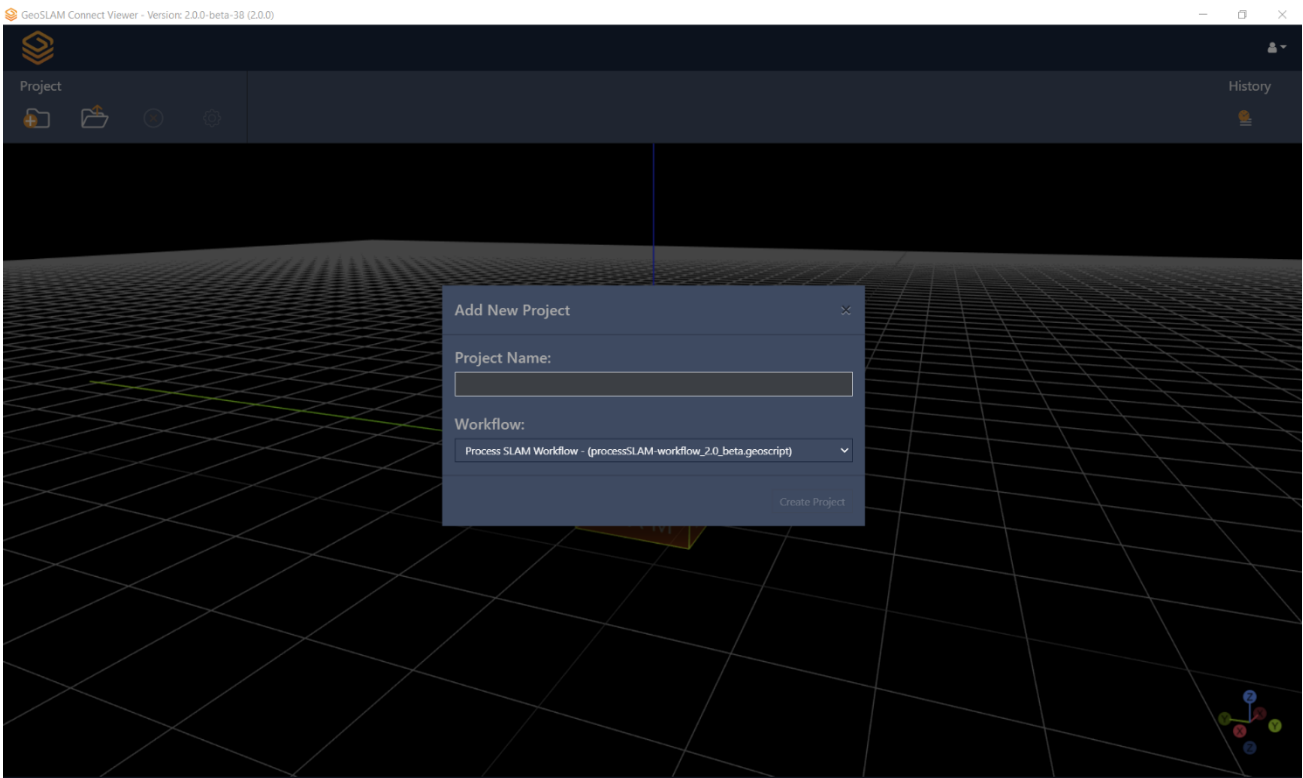

Figure 10-1

Drag the previously saved dataset into the window, select the required output parameters (file format, spatial decimation, etc.) and click “Import”.

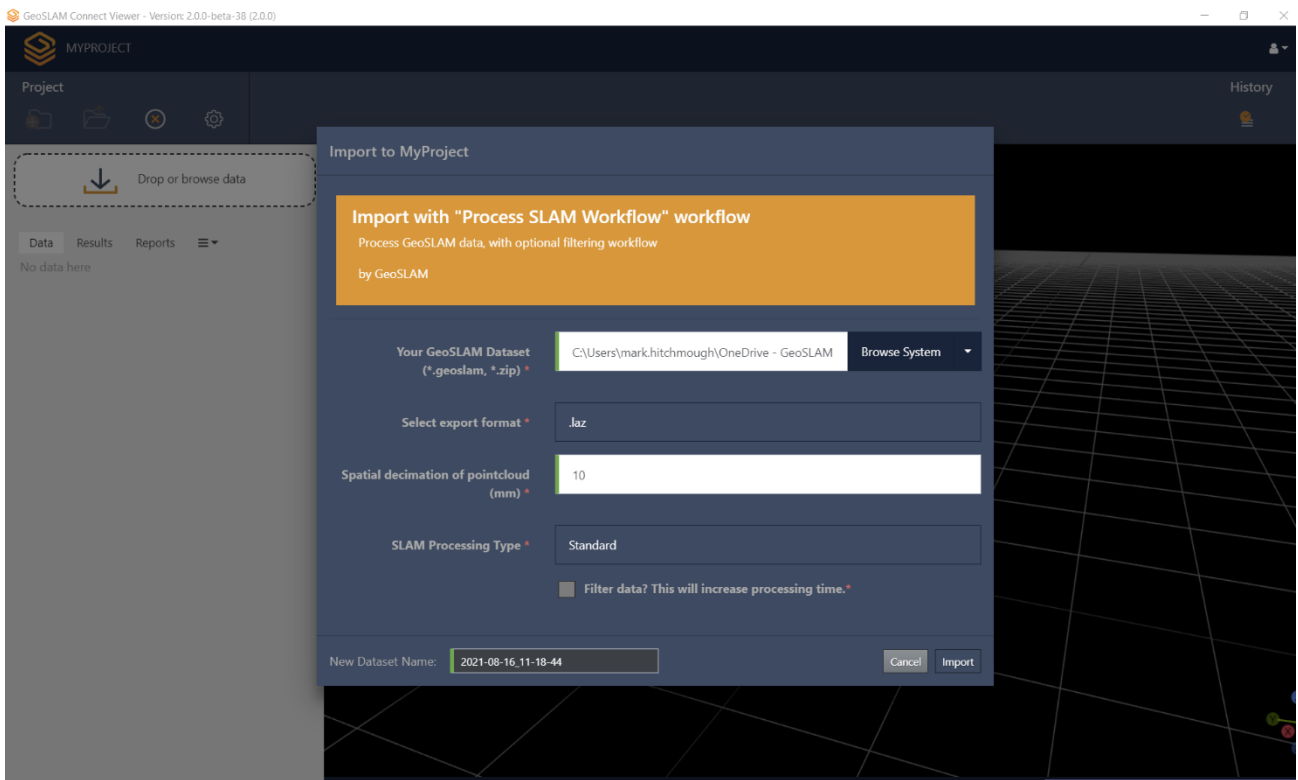

Figure 10-2

The dataset will be imported into GeoSLAM Connect and will automatically start to process. The processing time for a Horizon RT dataset is generally quick because the SLAM processing has already been completed during data capture. When the processing is complete the point cloud will be available for viewing and post-processing as shown in Figure 10-3.

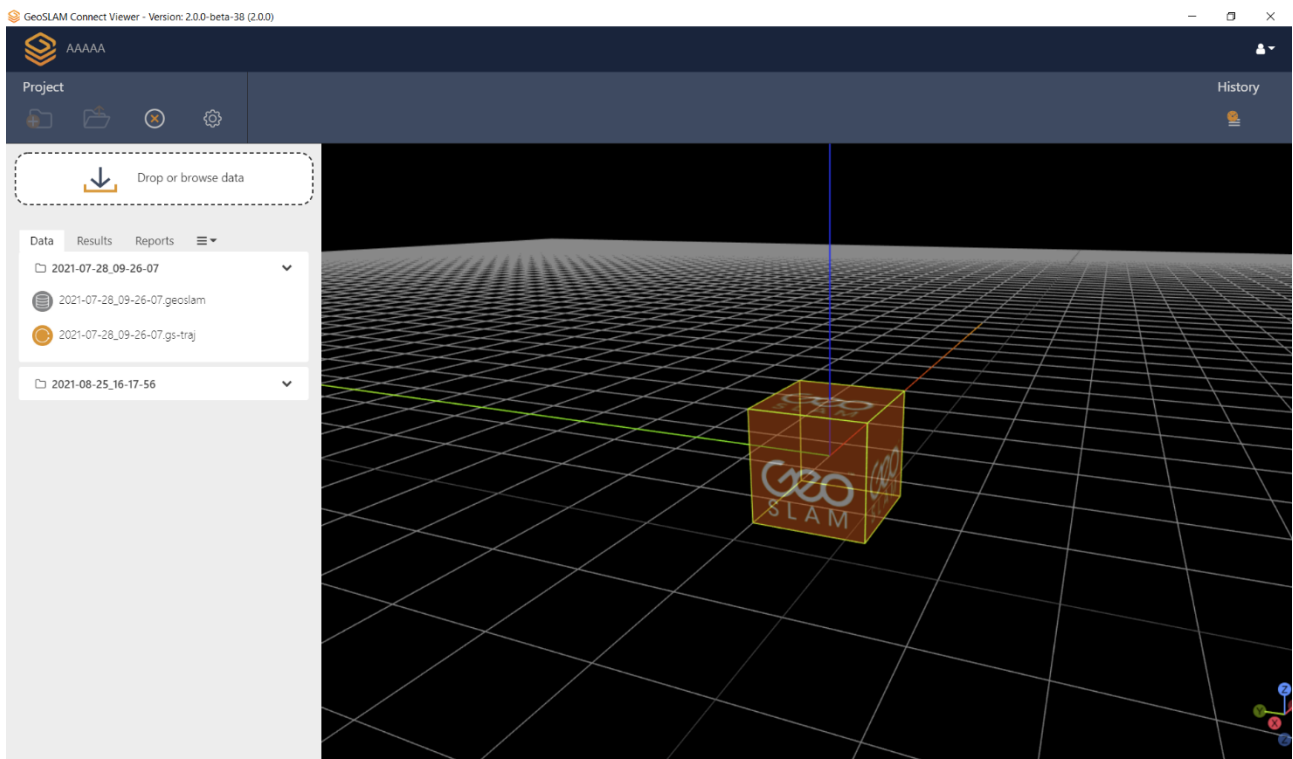

Figure 10-3

To view the point cloud, double click on the resultant .laz file name in the dataset list; this will appear in the Connect Viewer.

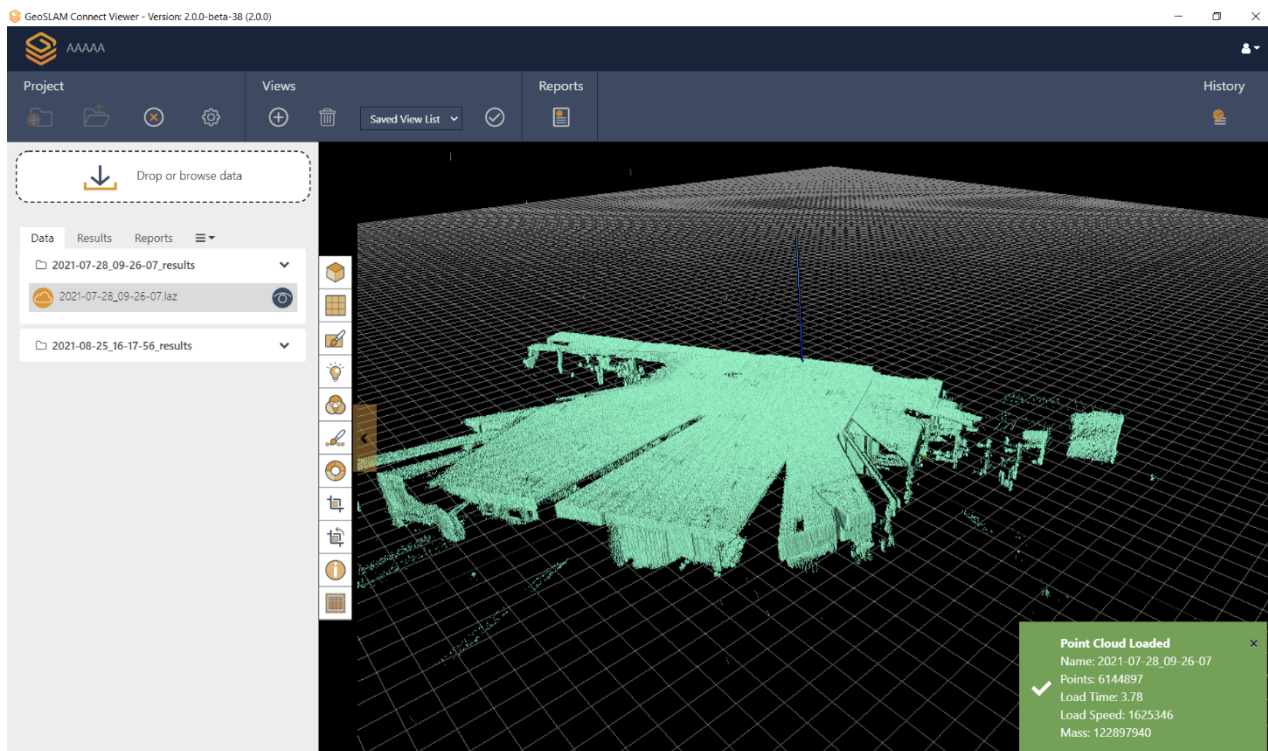

Figure 10-4

Further instructions for data export and the other processing options in GeoSLAM Connect are described in the separate GeoSLAM Connect User Guide which is available on the GeoSLAM Academy.

11. Appendices

11.1. Appendix 1 – USB Prepare Tool

A basic Windows™ application called USB Prepare has been created to enable users to perform some basic interaction with the ZEB Horizon datalogger. The USB Prepare tool can be obtained by emailing support@geoslam.com

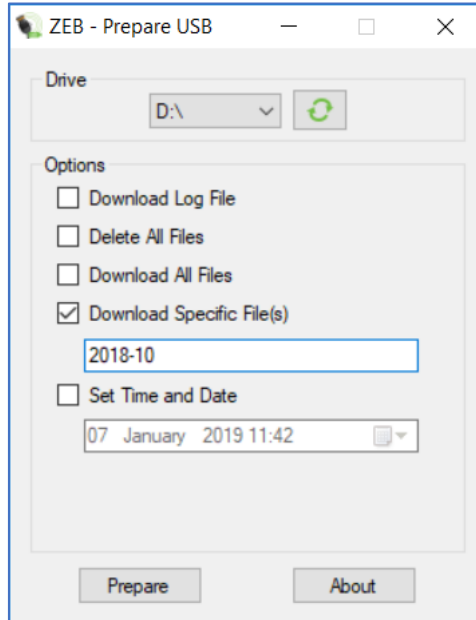

Figure 11-1

The following tasks can be performed:

- Download Log File
- Delete All Files
- Download All Files
- Download specific Files
- Set Time and Date

To perform any of the above tasks, insert a USB storage device into a USB port on your computer and start the USB Prepare Tool. Select the Drive letter for the USB storage device (see Figure 11-1) and check the tick box against the task you want to perform.

To **Download Specific Files**, enter the date of the required files (YYYY-MM-DD). The example in Figure 11-1 will download all data collected during October 2018.

To **Set Time and Date**, enter the required time and date.

Click **Prepare** and a small command file will be written to the USB storage device. Eject the USB memory from the computer and attached to it to the ZEB Horizon datalogger. Start the datalogger and the requested task(s) will be performed after the datalogger has booted. For the download tasks, the data will be written to the USB storage device. If you have selected **Download All Files** a USB storage device of at least 128GB is recommended.

11.2. Appendix 2 – Air Transport Certificate

PAG Ltd.
565 Kingston Road
London SW20 8SA
United Kingdom



Air Transport Certificate for PAG Li-Ion Batteries

PAG Ltd. London, England

hereby declares that the PAG L90 Slim Lithium-Ion battery has been tested and certified by Intertek Group PLC to comply with the UN Manual of Tests & Criteria, Part III, subsection 38.3 as required by the IATA Dangerous Goods Regulations (2016), Section 2.3.5.9.

PAG L90 Slim Battery Test Report Number: 102471069

In addition to UN testing, this Li-Ion battery has an individual Watt-hour rating below 100Wh. This rating is in compliance with the IATA DGR (2016) which states:

*(a) each installed or spare battery must not exceed:
2. for lithium ion batteries, a watt-hour rating of not more than 100Wh.*

Signed for and on behalf of PAG Ltd.

A handwritten signature in black ink that reads 'Alan Lavender'.

Alan Lavender
Chief Executive
Date: 01.04.16.



11.3. Appendix 3 – Dimensional Drawings

Figure 11-2
Dimensional
with
mounting
rear face.

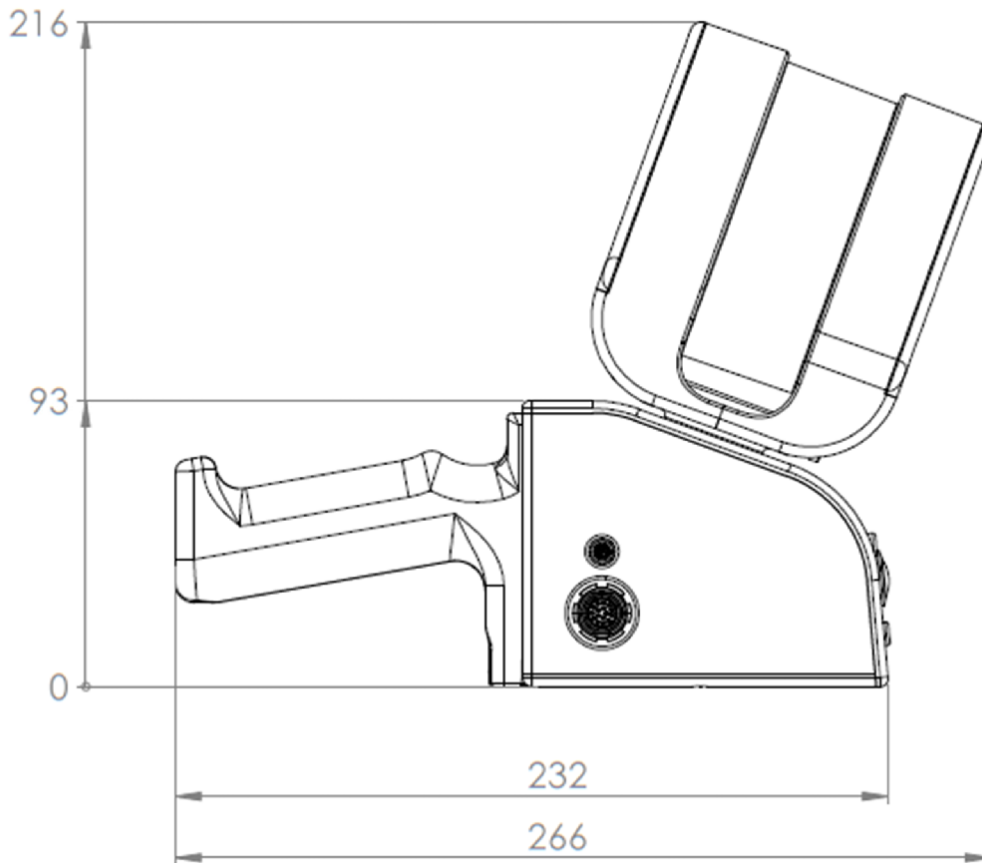

:
drawings
optional
plate on

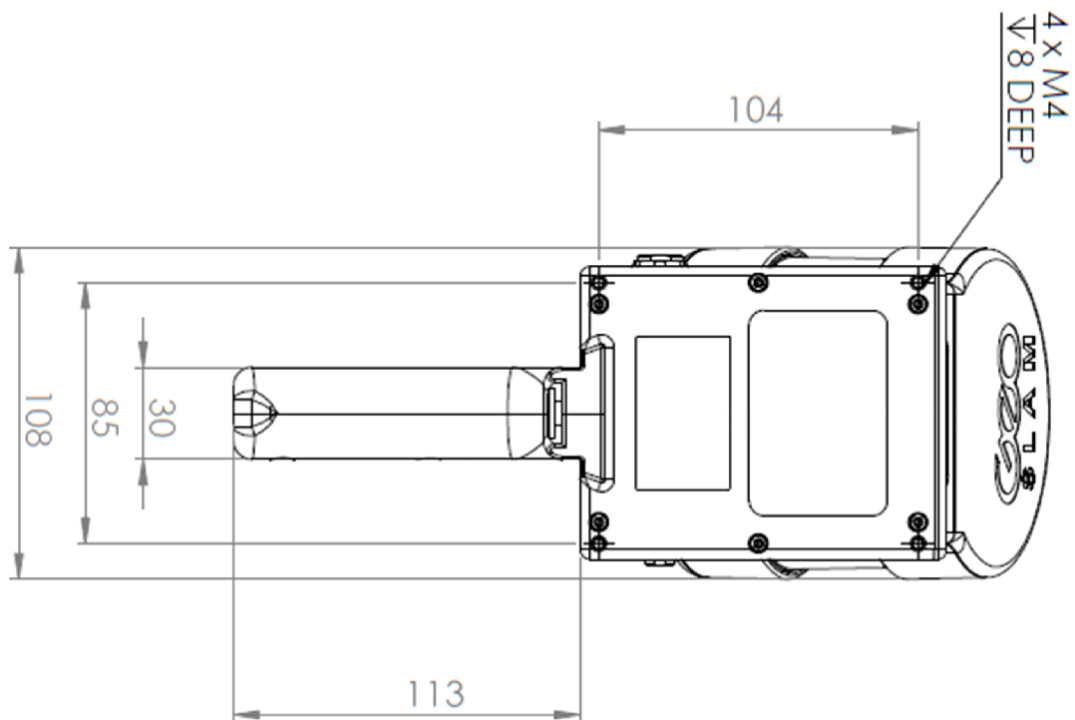

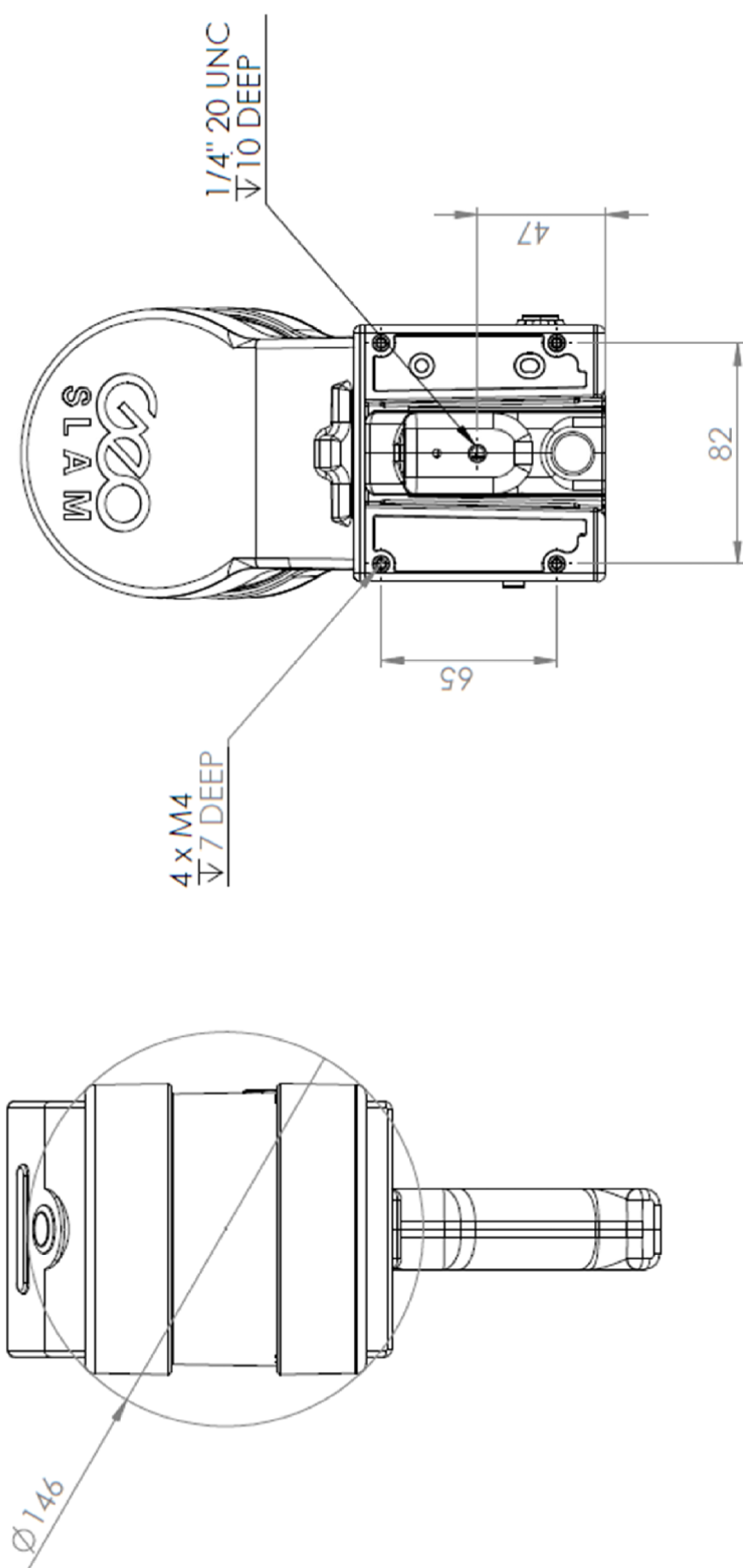

Figure 11-3 : Dimensional drawings with optional mounting plate on bottom face